

Nyquist and His Seminal Papers

Karl Johan Åström

Department of Mechanical Engineering

University of California Santa Barbara

Harry Nyquist 1889-1976

A Gifted Scientist and Engineer

Johnson-Nyquist noise

The Nyquist frequency

Nyquist's Stability Criterion



Introduction

- **Thank you for honoring Nyquist**
- **Thank you for inviting me to give this lecture**
- **Nyquist was awarded the Rufus Oldenburger medal in 1975**
- **The person and his contributions**
- **What we can learn**

1. Introduction
2. A Remarkable Career
3. Communications
4. Johnson-Nyquist Noise
5. Stability Theory
6. Summary

A Remarkable Career

Born in Nilsby Sweden February 7 1889

6 years in school

Emigrated to USA 1907

Farmhand

Teachers College

University of North Dakota

PhD Physics Yale University 1917

AT&T Bell Labs 1917-1954

Consultant 1954-1965





ASME Nyquist Lecture 2005

Becoming a Teacher is my Dream

- **Emigrated 1907**
- **Southern Minnesota Normal College, Austin Active as in teaching**
- **Back to SMNC**
- **Exam 1911 valedictorian**
- **High School Teacher 1912**



A Dream Comes True

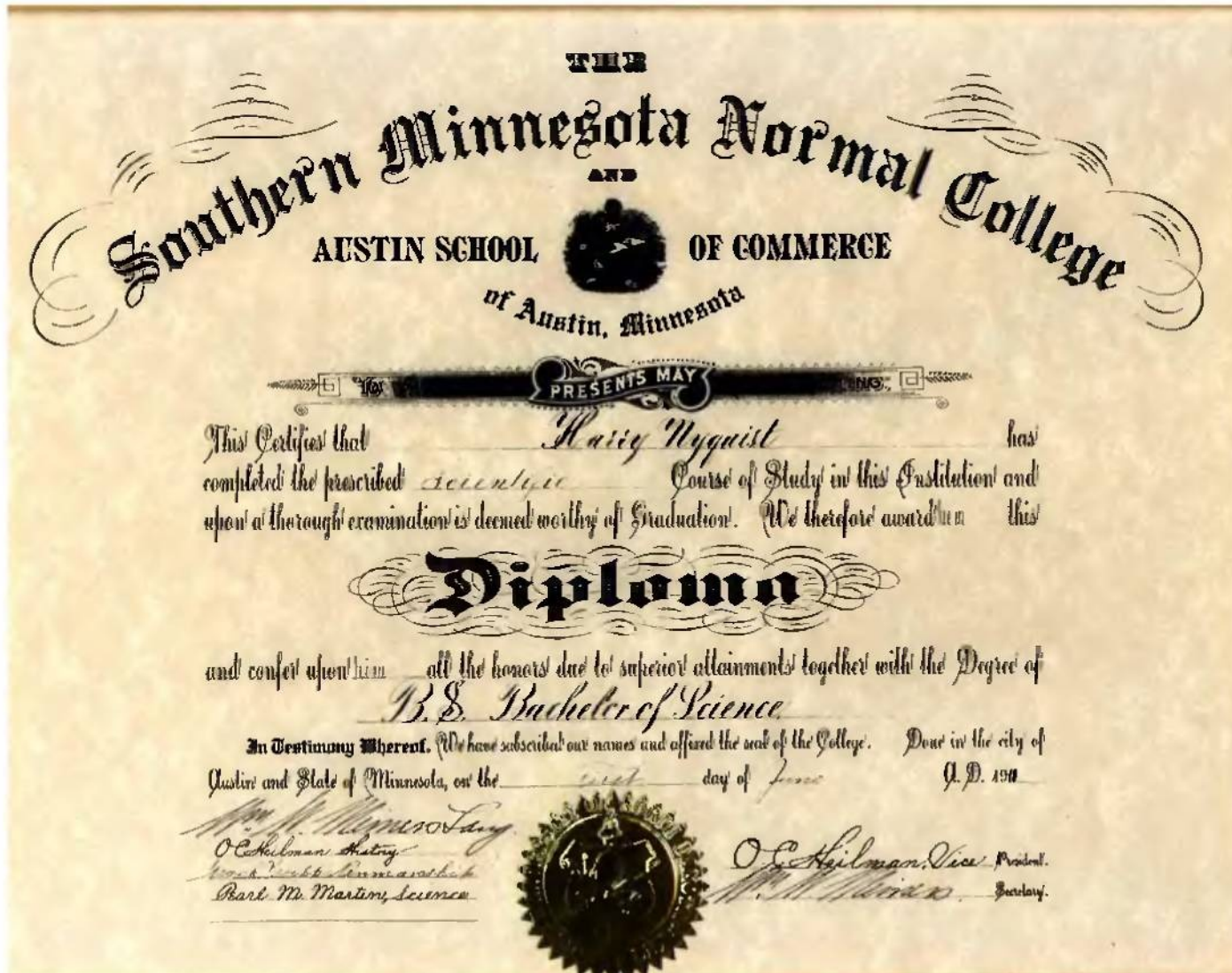

ASME Nyquist Lecture 2005

Academia Pulls

**University of North Dakota BS EE 1914 MS EE 1915
Very active in student organizations met Johnson**

Yale University PhD Physics 1917. Thesis topic: On the Stark effect in Helium and Neon. Largely experimental.

A Career in AT&T Bell

- **1917 AT&T Engineering Department**
- **1919 Department of Development and Research**
- **1935 Bell Labs**
- **World War II**
- **1952 Assistant director fo Systems Studies**
- **1954 Retired**
- **1954-1962 Consulting**

The ATT Early Fax commercial from 1925

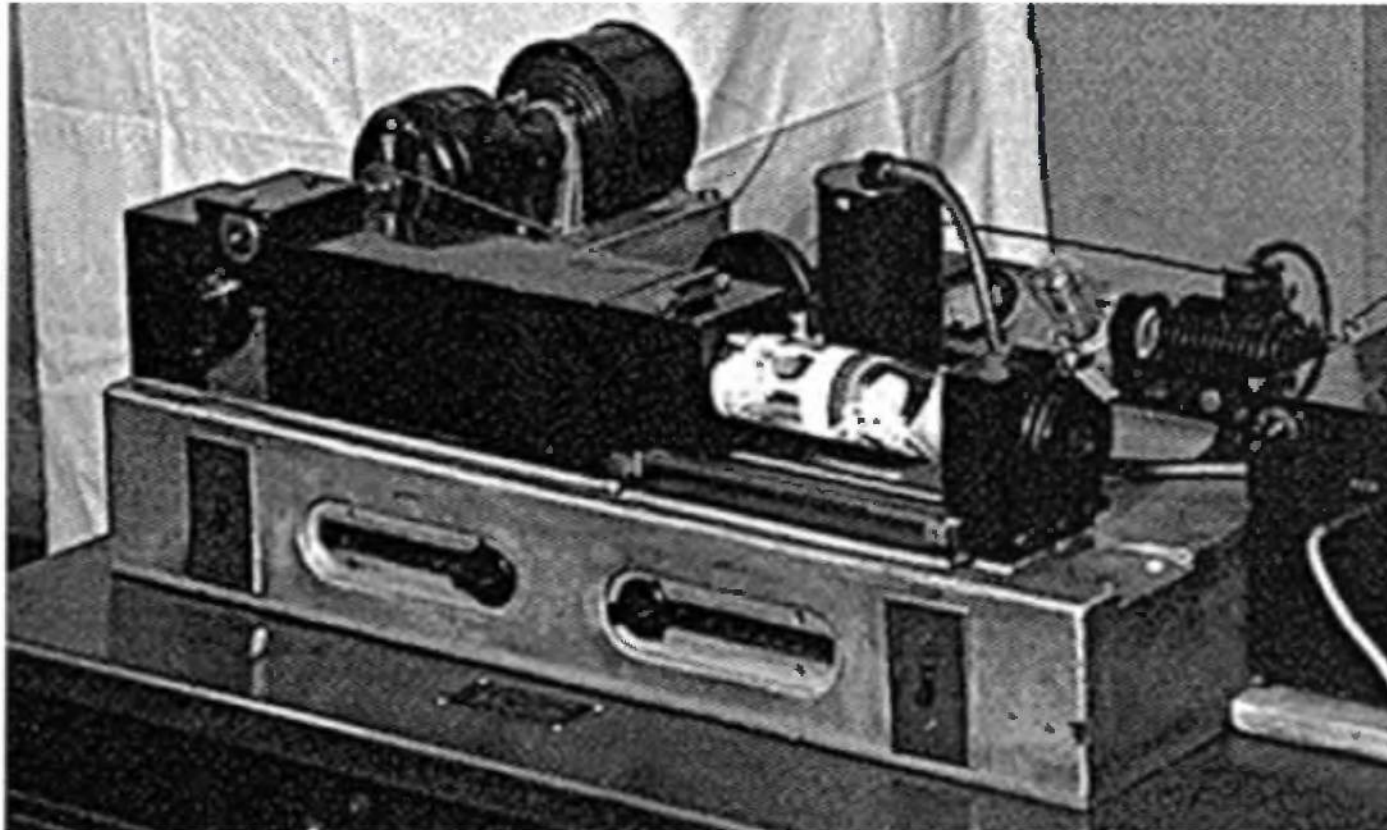

An Unusual Research Lab

Control the telephone monopoly

Key technologies

Creative research environment

Extremely successful

6 Nobel prizes (11 researchers)

Radioastronomy, solid state physics

Unix, C

Statistical quality control

In His Right Environment

- **Nyquist thrived, challenging problems, clever colleagues, interesting.**
- **Nyquist was a much better mathematician than most men who tackled the problems of telegraphy, and he has remained a clear, original, and philosophical thinker concerning communication. He tackled the problems of telegraphy with powerful methods and with clear insight.**

Nyquists Contributions

- Improvement of telegraphy and fax
- **Thermal noise**
- **The Nyquist frequency**
- Long distance telephony and TV
- Electronic amplifiers, **the stability criterion**
- Military project, cryptography

Nyquist had 138 patent

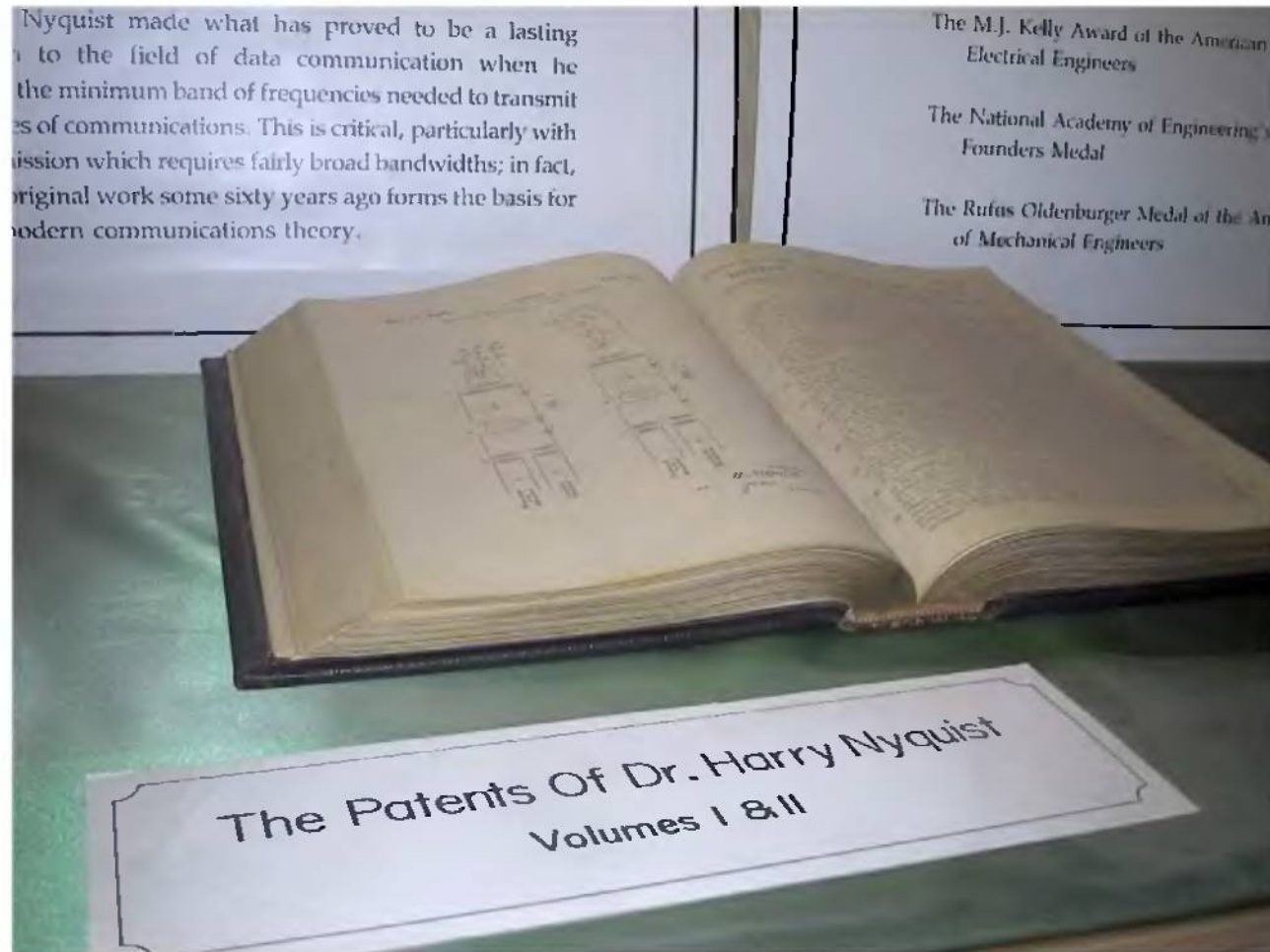

ASME Nyquist Lecture 2005

Many Awards

- **1960 Stuart Ballantine Medal Franklin Institute**
- **1960 IEEE Medal of Honor**
- **1961 The Melvin J Kelley Award**
- **1969 Founders Medal NAE**
- **1975 Rufus Oldenburger Medal ASME**

1. Introduction
2. A Remarkable Career
- 3. Communications**
4. Johnson-Nyquist Noise
5. Stability Theory
6. Summary

The Papers

Nyquist, H. (1922) Certain factors affecting telegraph speed. Bell System Technical Journal 3, pp.~324--346.

Nyquist, H. (1928) Certain topics in telegraph transmission theory. Trans. Am. Inst. Elec. Eng. 47, pp.~617--644.

The Nyquist frequency – Part 2

- Bandwidth required to transmit analog signal digitally?
- How fast should the signal be sampled?

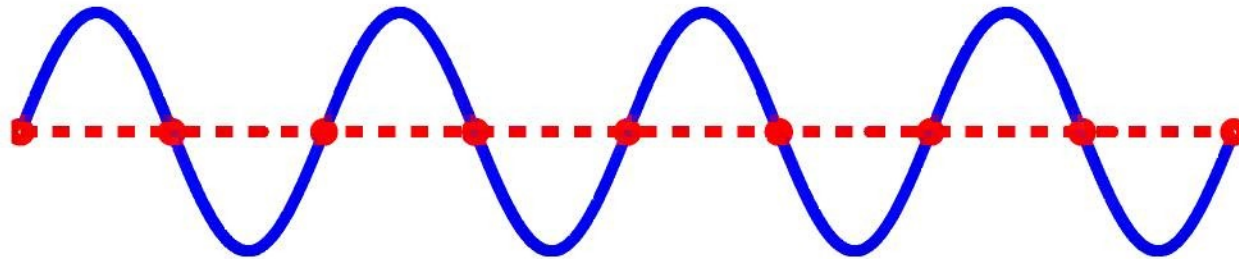

- The samplingsfrequency is är twice the Nyquist frequency
- CD $f=22$ kHz $f_s=44.1$ kHz
- Theory completed by Shannon och Kotelnikov
- It is a key element in all computer controlled systems
- Do not forget the prefilter!

1. Introduction
2. A Remarkable Career
3. Communications
- 4. Johnson-Nyquist Noise**
5. Stability Theory
6. Summary

The Papers

Johnson, J. B. 1928. Thermal agitation of electricity in conductors. Phys. Rev. 32, pp. 97--109.

Nyquist, H. 1928. Thermal agitation of electrical charge in conductors. Phys. Rev. 32, pp. 110--113.

Thermal noise

- **Johnson and Nyquist were buddies from University of North Dakota and colleagues at AT&T**
- **Thermal noise is found everywhere in electrical systems**

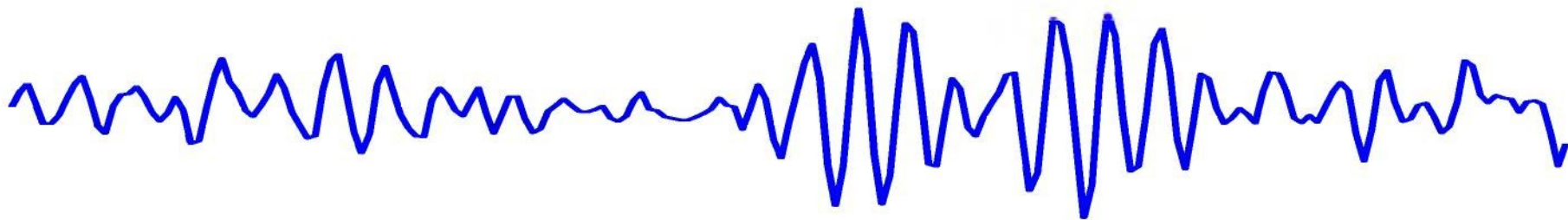

- **Johnson developed precise measurement and Nyquist explained**
- **Thermal noise or Johnson-Nyquist noise**
- **Fundamental limitations in precision measurements**
- **Highly relevant in today's MEMS systems**

The Formula

Johnson had found experimentally that thermal noise variance was proportional to temperature

The power of thermal noise in a resistor is

$$4RkTB$$

Where R is resistance, k Boltzmanns constant, T [K] absolute temperature and B [Hz] the bandwidth (single band)

Stochastic Control Theory

$$C \frac{dV}{dt} = I = \frac{V + V_n}{R}$$

$$dV = -\frac{1}{RC} V dt - \frac{1}{RC} dV_n$$

$$P = EV^2$$

$$\frac{dP}{dt} = -\frac{2}{RC} P + \frac{r_n}{(RC)^2}$$

$$E \frac{1}{2} CV^2 = \frac{1}{2} PC = \frac{r_n}{4R} = \frac{1}{2} kT$$

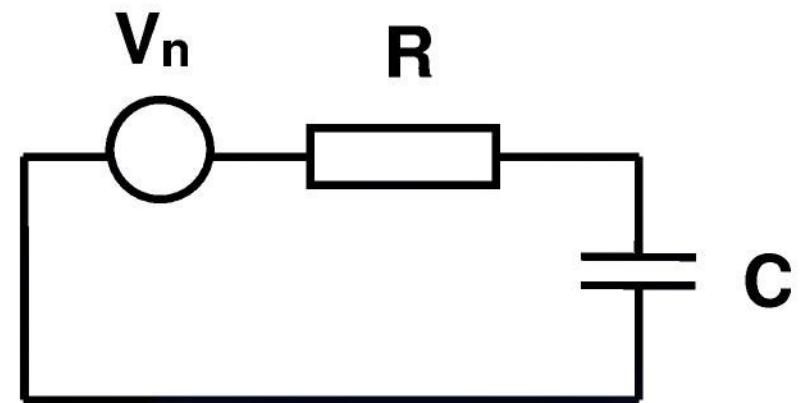

$$r_n = 2RkT$$

Much appreciated by colleagues

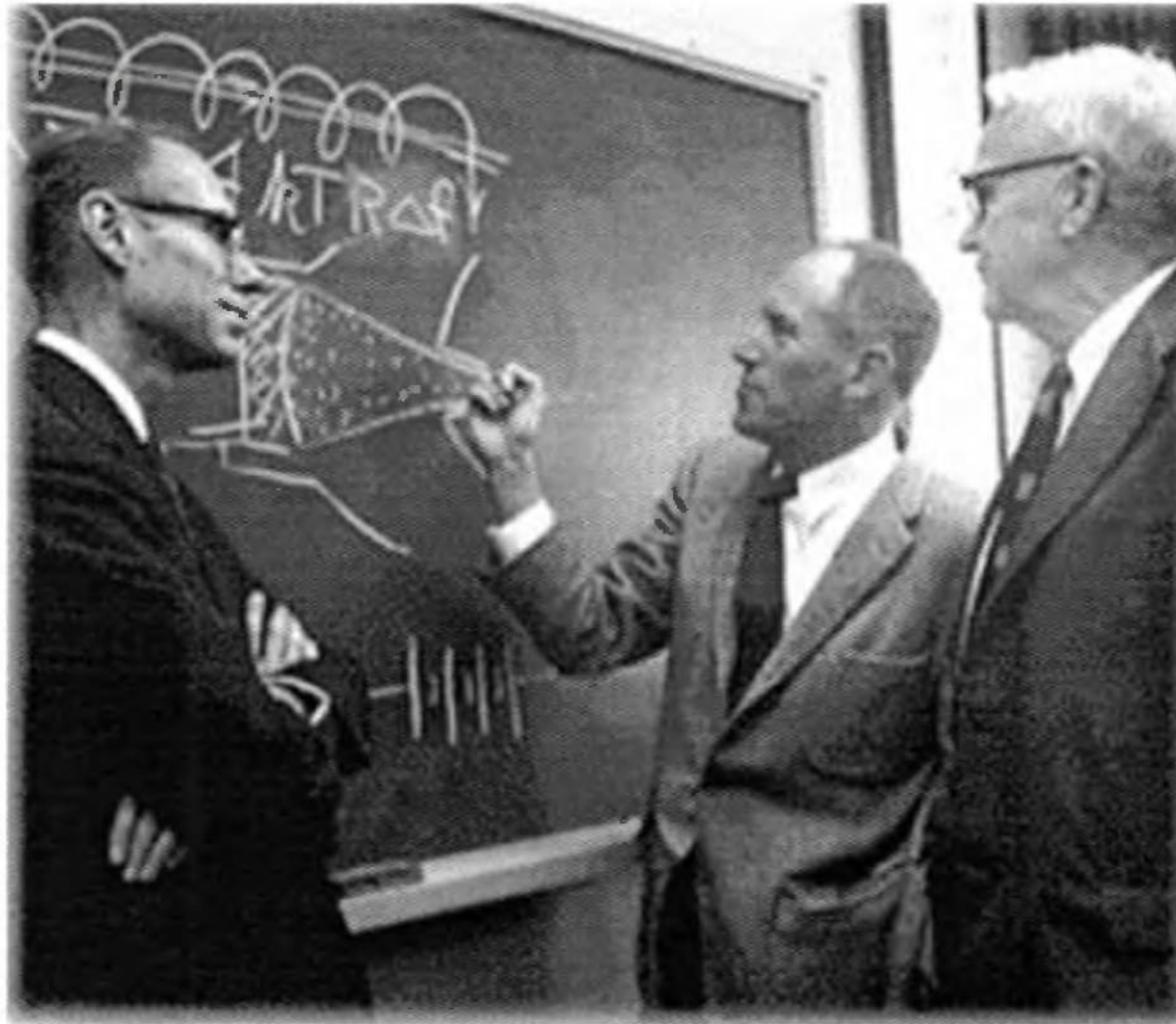

ASME Nyquist Lecture 2005

Comments by Johnson

The results were discussed with Dr. H. Nyquist, who in a matter of a month or so came up with the famous formula for the effect, based essentially on the thermodynamics of a telephone line, and covering almost all one need to know about thermal noise.

Comments by Pierce

Nyquist's fusing of concepts from two quite different fields, statistical mechanics and electrical engineering, points out what has been a particular strength of Bell Labs work in theoretical physics: the diversity of expertise among the theoretical staff, and the propensity of many of them to shift their attention from one area to another, transferring useful concepts in the process.

1. Introduction
2. A Remarkable Career
3. Communications
4. Johnson-Nyquist Noise
- 5. Stability Theory**
6. Summary

The Paper

Nyquist, H. 1932. Regeneration theory. Bell System Technical Journal, 11, pp. 126--147.

**Reprinted in Bellman and Kalaba (editors)
Mathematical Trends in Control Theory, Dover 1964.**

Reprinted in Basar (editor) Control Theory - Twenty-five seminal papers. IEEE Press 2001.

Nyquist's stability criterion

- **Feedback makes it possible to design good systems from bad components, but feedback can give rise to instability (singing)**
- **Nyquist introduced a completely new way to look at the stability problem**

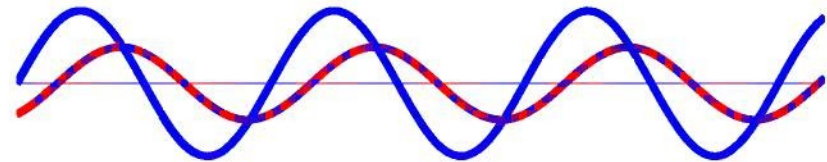
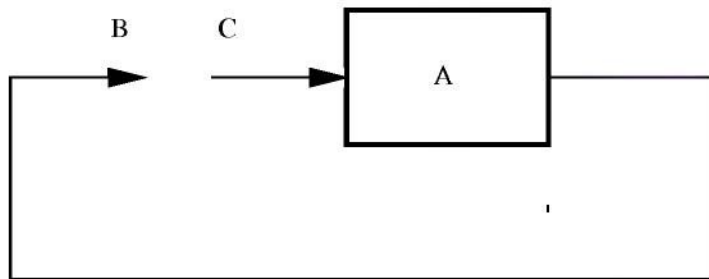

- **Easy to see how a system can be stabilized**

Conditionally Stable Systems

This case is intuitive

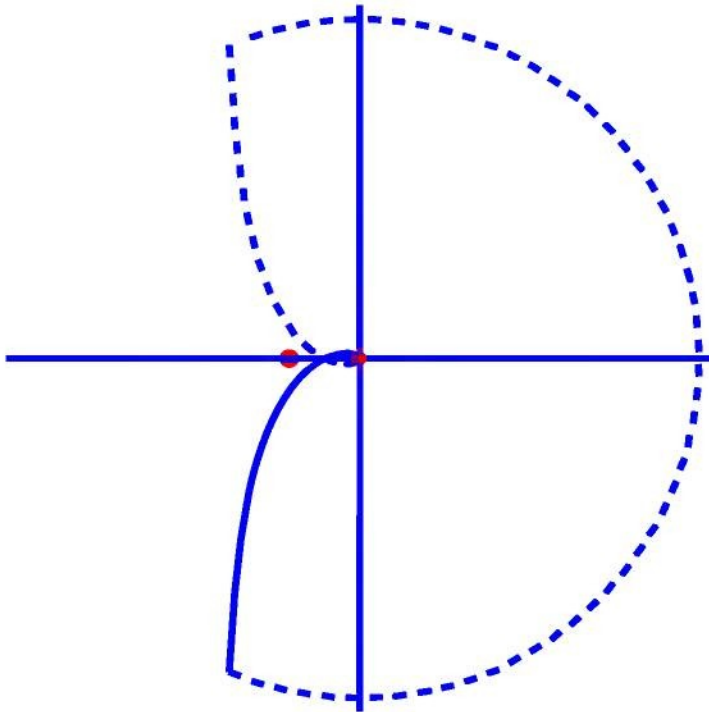

But what about this?

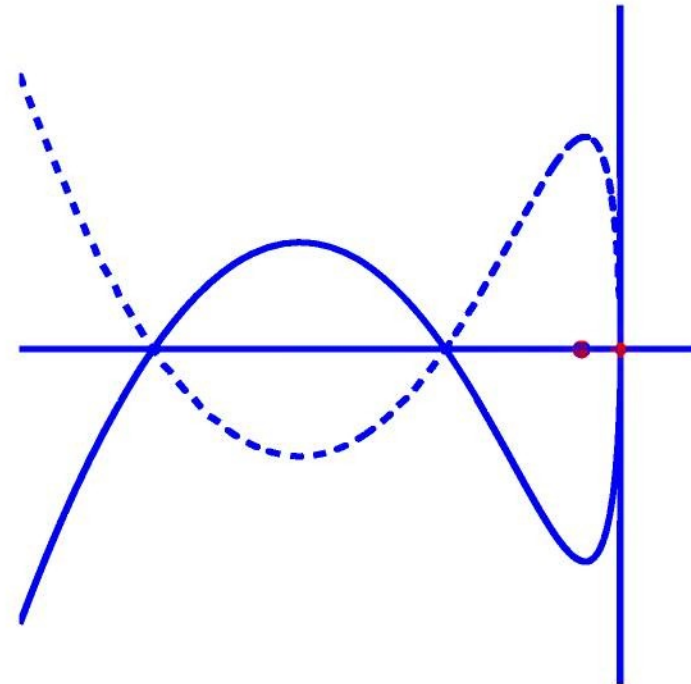

The Nyquist curve gives insight

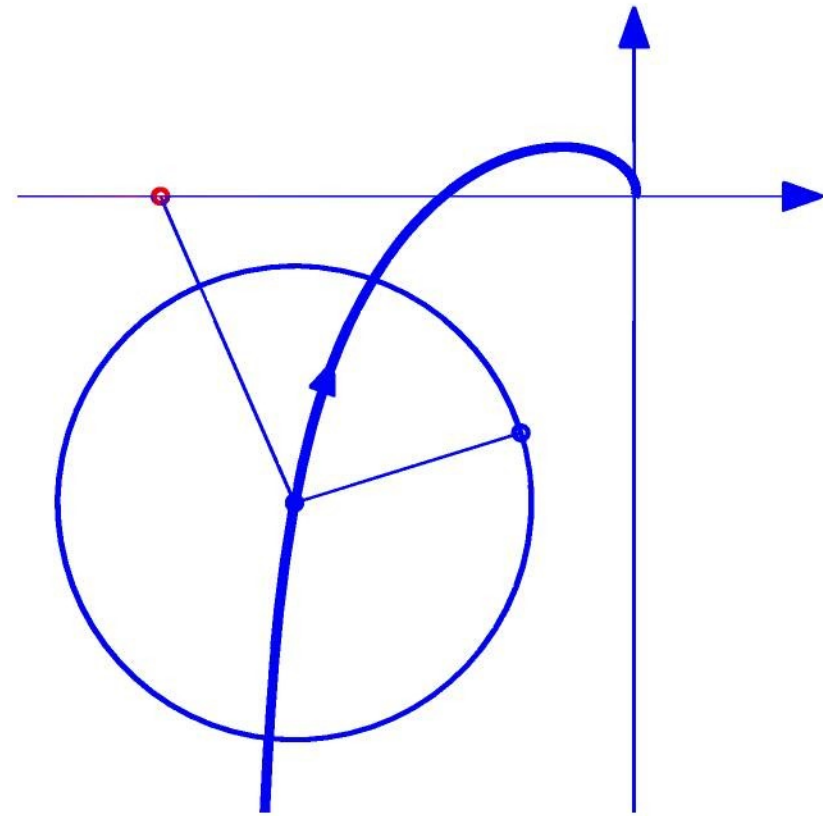
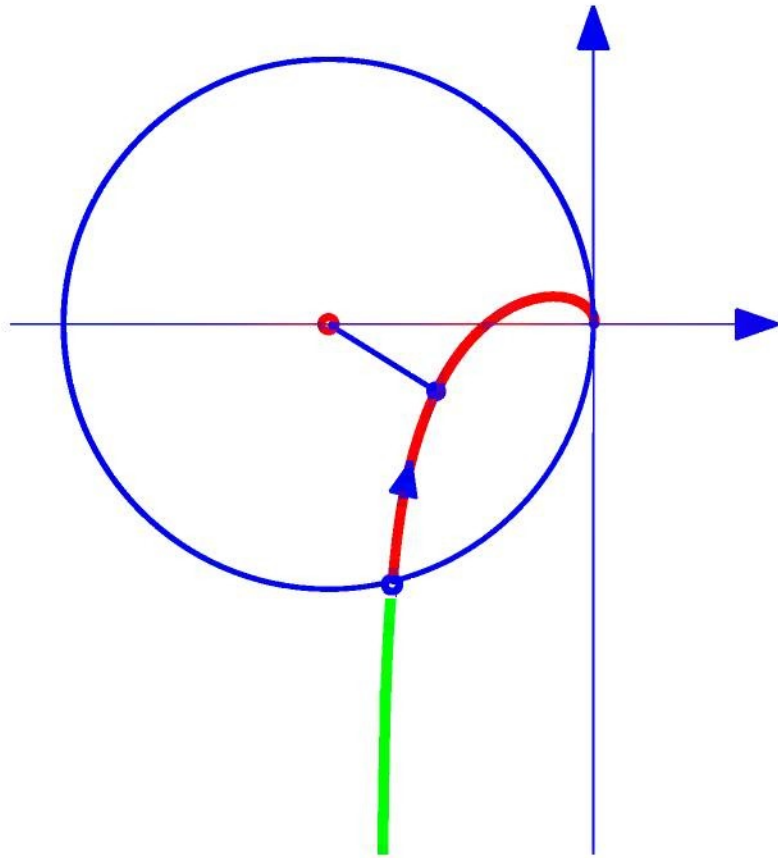

More insight

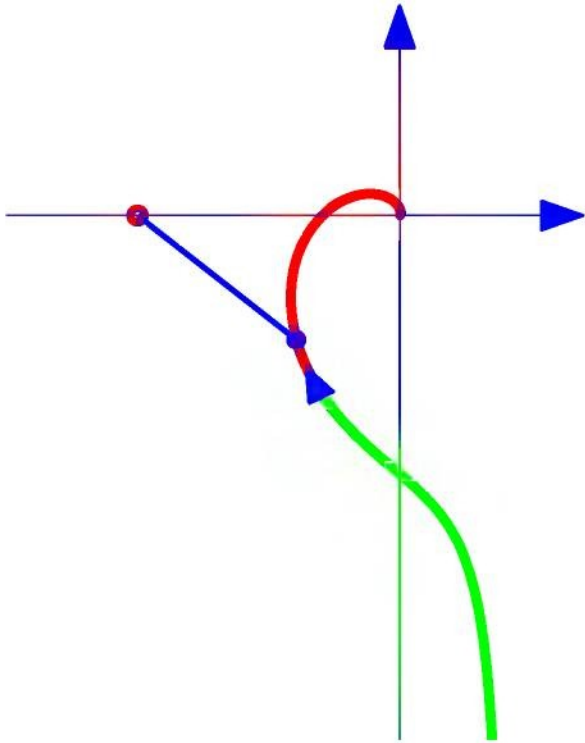

Too small integral action

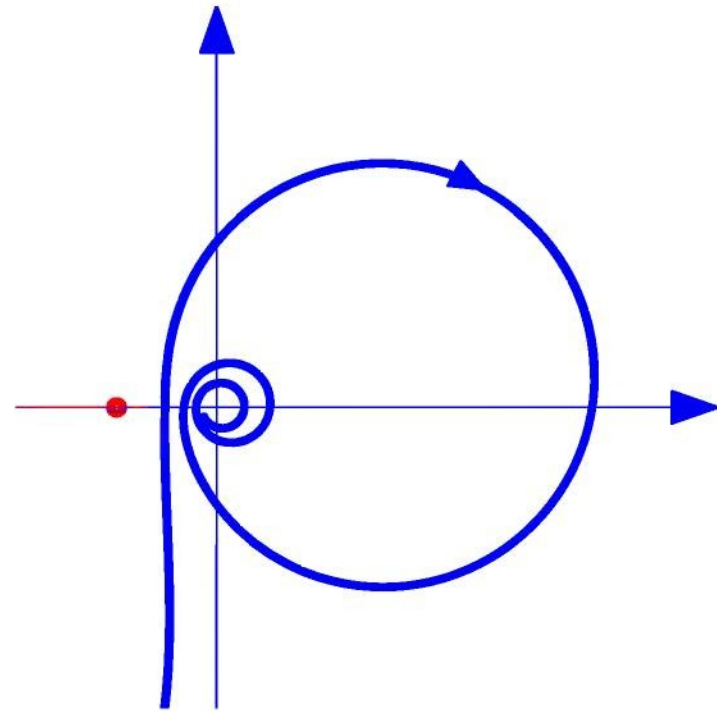

**Small delays may cause instability
gain and phase margins misleading**

Comments from ASEA (ABB)

- **The spirit of the times (1940), poor computational tools (calculators). Design by trial and error, compute roots of characteristic equations manually. No idea how to change a system to make it stable.**
- **For the first time we could determine how to change the controller to stabilize a system**
- **Knowledge about Nyquist's paper changed control from trial and error to systematic design**
- **A simple direct method to get models from experiments**
- **A multivariable design methodology by combining Nyquist plots from all measured signals**
- **Numerous applications: power systems, motor drives, ...**

Example of Project from 1944

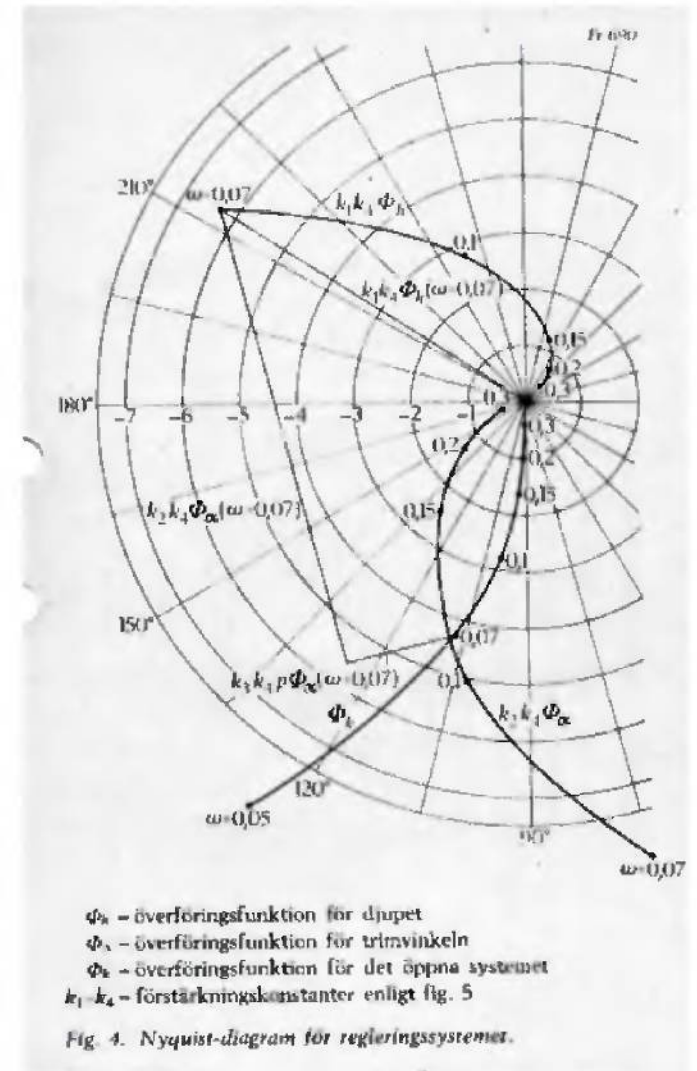
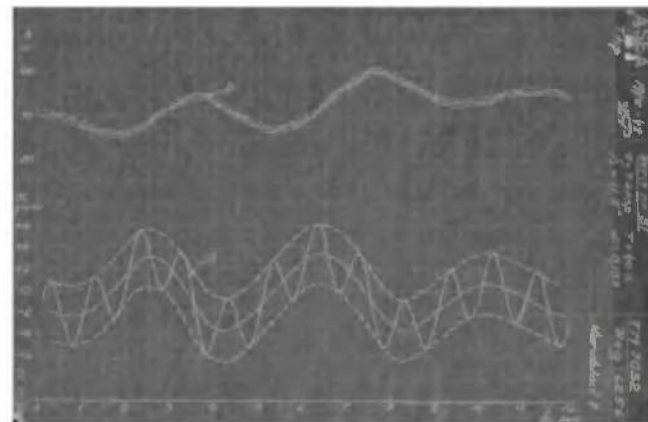
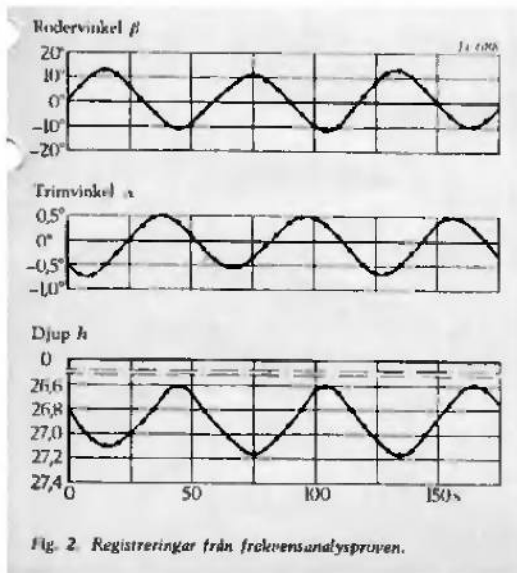
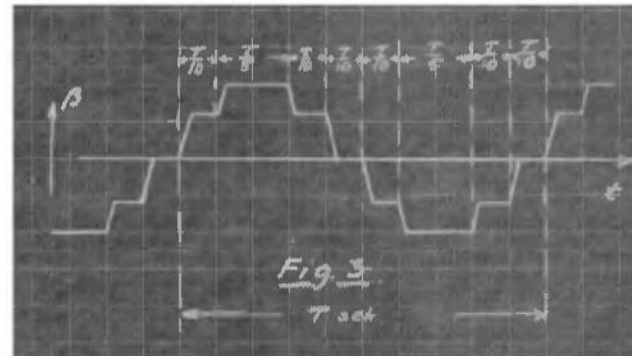
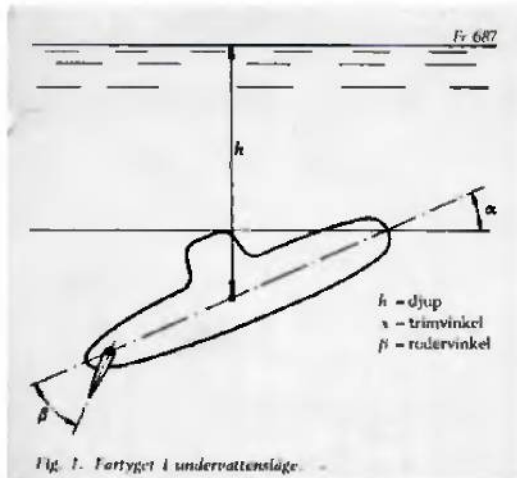

Frequency Response

- **Characterize a system by transmission of sinusoids**
- **A Paradigm shift from differential equations**
- **The concept of transfer function**
- **Efficient way to determine dynamics experimentally**
- **Constructive design method**
- **Opened the door for theory of complex functions**
- **Bodes relations and integrals**
- **The importance of amplitude and phase**
- **The small gain and passivity theorems**

1. Introduction
2. A Remarkable Career
3. Communications
4. Johnson-Nyquist Noise
5. Stability Theory
6. Summary

The Importance of Fundamentals

Nyquist solved specific engineering problems for the 1930s technology.

His results have had long lasting impact

He focused on fundamentals, formulated clean problems and used good mathematics to solve them

He wrote few concise papers with tremendous impact

A hard working problem solver

His daughter Phoebe: “I think one of the ways he succeeded in accomplishing so much is that he was very disciplined. The alarm always rang at 6:45 at our house. He always got right up. While mother fixed his breakfast he got dressed and was out the door punctually at 7:30. You could set your watch by it, but he never hurried. He walked a mile to the train station and rode in to NYC. His return home was just as regular, so we could plan on eating at 6:15 PM. Some days he took the ferry across the Hudson River instead of the tubes under the water because the air was fresher. He did like being outdoors. I have a picture of him of him stretched out on the lawn taking a nap. He always reserved Saturday for household chores and Sunday was church, a good dinner and time to read or think. He frequently had a legal size yellow notebook on his lap and started figuring those equations. I suppose he couldn't let go of a problem until he got it solved.”

Keys to Success

- **Talent and creativity**
- **Ability to find good stimulating environments**
- **Curiosity**
- **Energy**
- **Searched fundamental problems**
- **Catch the essence abstract away details**
- **Sound use of mathematics**

A Modest Person

- **My impressions and feelings as a stranger in the new country: I don't think it was any different from what it would have been if I had gone to Karlstad or Stockholm.**
- **Distinctions I have received: I have received honors for technical work.**
- **Literary works, books, etc: I have published a few technical papers.**
- **Inventions discoveries, other notable achievements: I have been granted a number of patents.**

Harry Nyquist 1889-1976

Johnson-Nyquist noise
The Nyquist frequency
Nyquist's Stability Criterion
Importance of fundamentlas



Thank You